

Operating Instructions

VACUUM CLEANER
MC-V7320

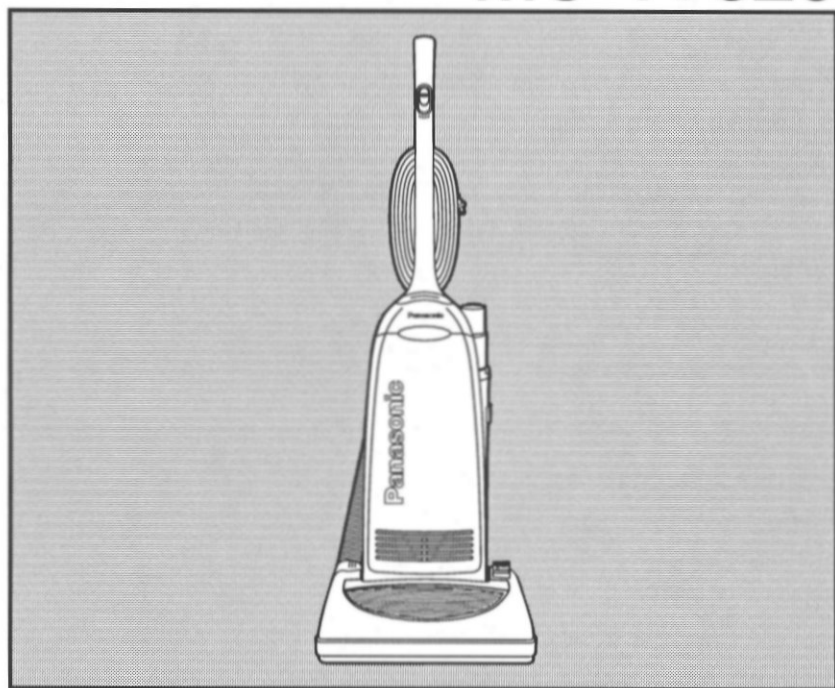

Panasonic®

Before operating your vacuum cleaner, please read these instructions completely.

CONSUMER INFORMATION

Please read **IMPORTANT SAFETY INSTRUCTIONS** on page 4 before use. Read and understand all instructions.

TO OUR VALUED CUSTOMER

We are very pleased to welcome you to the Panasonic family of products. Thank you for purchasing this product. Our intent is that you become one of our many satisfied customers.

Proper assembly and safe use of your vacuum cleaner are your responsibilities. Your cleaner is intended only for household use. The cleaner should be stored in a dry, indoor area. Read the Operating Instructions carefully for important use and safety information.

PLEASE PAY CLOSE ATTENTION TO THE WARNING AND CAUTION STATEMENTS THAT ARE FOUND THROUGHOUT THIS MANUAL.



WARNING statements are designed to alert you to the possibility of personal injury, loss of human life, and/or damage to the vacuum cleaner and/or personal property if the instructions given are not followed.



CAUTION statements are designed to alert you to the possibility of damage to the vacuum cleaner and/or personal property if the instructions given are not followed.



TO AVOID ELECTRICAL SHOCK

Never vacuum damp or wet surfaces or liquids.
Do not store machine outdoors.
Replace worn or frayed power cord immediately.

TO AVOID ACCIDENTS

Except for hand-held cleaners, keep machine on floor - not chairs, tables, steps, stairs, etc.
Store machine promptly after each use to prevent accidents such as tripping over power cord or machine.
Use machine and accessories only in a manner intended by the manufacturer.
The use of an extension cord is not recommended.

TABLE OF CONTENTS

CONSUMER INFORMATION	2
IMPORTANT SAFETY INSTRUCTIONS	4
PARTS IDENTIFICATION	5
Feature Chart	5
TO ASSEMBLE CLEANER	6
Attaching Handle to Vacuum Cleaner	6
Using the Cord Hook	6
Attachment (Tools-on-Board) Assembly	7
SPECIAL FEATURES OF CLEANER	8
Automatic Self Adjusting Nozzle	8
Edge Cleaning Feature	8
Dirt Sensor	8
Carpet/Bare Floor Selector	9
Hose Ring and Hose Ring Mount	9
TO OPERATE CLEANER	10
Power Cord	10
On/Off Switch	10
Handle Adjustments	11
Dirt Sensor	11
Use of Attachments	12
ROUTINE CARE OF CLEANER	13
Cleaning Secondary Foam Filter	13
Replacing Electrostatic Exhaust Filter	13
Changing the Dust Bag	14
Removing/Installing the Lower Plate	15
Replacing the Headlight Bulb	15
Replacing the Drive Belt	16
Cleaning the Agitator Assembly	16
Replacing the Agitator Assembly	17
Cleaning Dirt Sensor Optics	18
Cleaning Exterior and Attachments	18
Removing Clogs	19
BEFORE REQUESTING SERVICE	20
NOTES	21-22
WARRANTY	23
WHAT TO DO WHEN SERVICE IS NEEDED	Back Cover

IMPORTANT SAFETY INSTRUCTIONS

When using vacuum cleaner, basic precautions should always be followed, including the following.

READ ALL INSTRUCTIONS BEFORE USING THIS VACUUM CLEANER

WARNING

To reduce the risk of fire, electrical shock, injury:

1. Do not leave vacuum cleaner when plugged in. Unplug from outlet when not in use and before servicing.
2. To reduce the risk of fire, electric shock - Do not use outdoors or on wet surfaces.
3. Do not allow to be used as a toy. Close attention is necessary when used by or near children.
4. Use only as described in this manual. Use only manufacturer's recommended attachments.
5. Do not use with damaged cord or plug. If vacuum cleaner is not working as it should, has been dropped, damaged, left outdoors, or dropped into water, return it to an Authorized Panasonic Service Center.
6. Do not pull or carry by cord, use cord as a handle, close door on cord, or pull cord around sharp edges or corners. Do not run vacuum cleaner over cord. Keep cord away from heated surfaces.
7. Do not unplug by pulling on cord. To unplug, grasp the plug, not the cord.
8. Do not handle plug or vacuum cleaner with wet hands.
9. Do not put any objects into openings. Do not use with any opening blocked; keep free of dust, lint, hair, and anything that may reduce air flow.
10. Keep hair, loose clothing, fingers, and all parts of body away from openings and moving parts.
11. Do not pick up anything that is burning or smoking, such as cigarettes, matches, or hot ashes.
12. Do not use without dust bag and/or filters in place.
13. Turn off all controls before unplugging.
14. Use extra care when cleaning on stairs.
15. Do not use cleaner to pick up flammable or combustible liquids such as gasoline or use in areas where they may be present.

SAVE THESE INSTRUCTIONS

THIS VACUUM CLEANER IS INTENDED FOR HOUSEHOLD USE ONLY

Notice: Before you plug in your Panasonic Vacuum Cleaner, make sure that the voltage indicated on the rating plate located at the back of the vacuum cleaner is the same as your local supply.

PARTS IDENTIFICATION

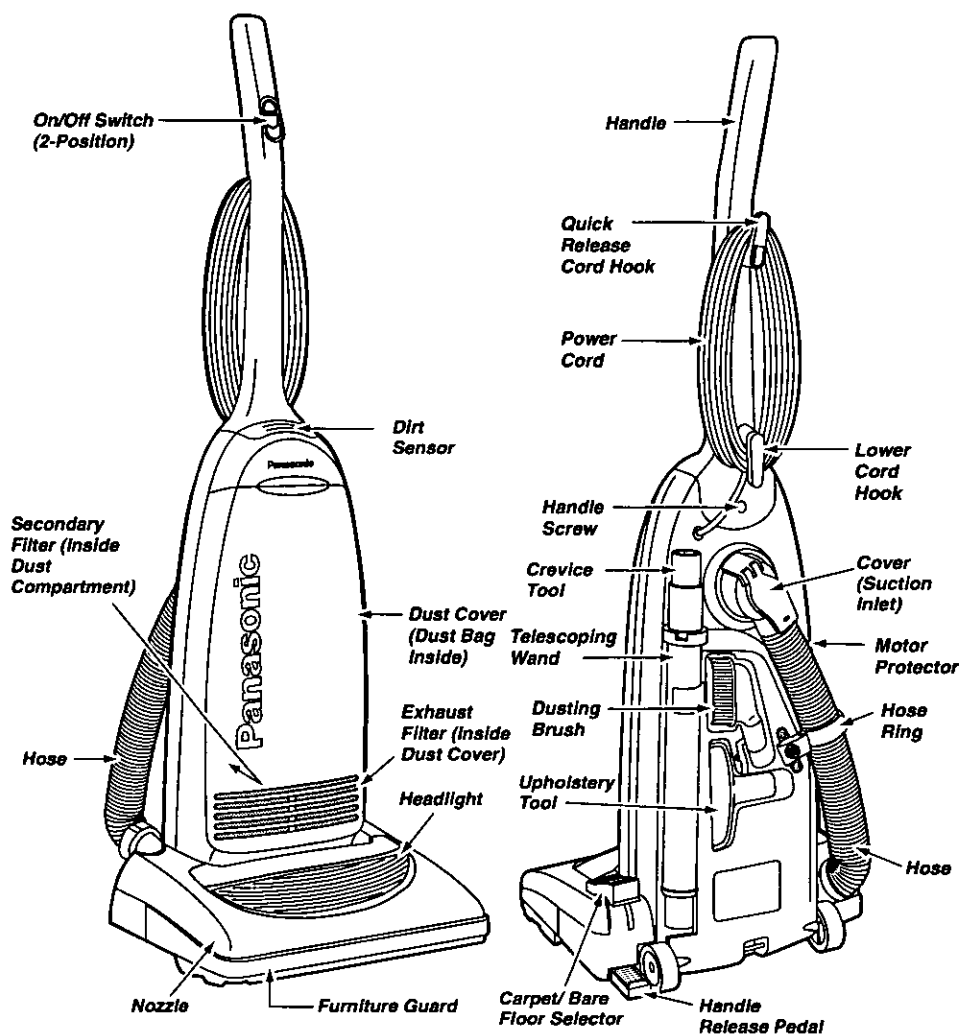

FEATURE CHART

(PANASONIC UPRIGHT VACUUM CLEANER)

FEATURES	POWER	DIRT SENSOR	BARE FLOOR OPTION	HEADLIGHT	CORD LENGTH (feet)
Model					
MC-V7320	120V. AC(60-Hz) 12.0 Amps	Yes	Yes	Yes	30

TO ASSEMBLE CLEANER



WARNING *Electrical Shock Hazard*

Do not plug into electrical supply until assembly is complete. Failure to do so could result in electrical shock or injury.

ATTACHING HANDLE TO VACUUM CLEANER

The vacuum cleaner main body and handle are packed separately.

- 1 The handle screw has been installed for shipping purposes. Please remove the screw before inserting handle. Insert the handle as shown in the illustration. **Make sure the On/Off switch is in the Off position before installing.**

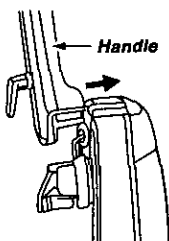

- 2 Insert the screw that you removed. Be sure the screw is tightened, but not overtightened.

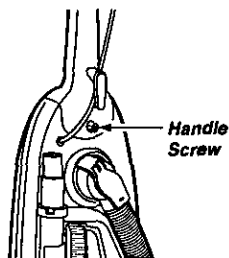

- 3 There is a recessed area between the upper cord storage hook base and the handle that is designed to secure the cord during vacuuming.

Always push the power cord down into this recessed area to help keep the cord from hanging near the nozzle and being damaged.

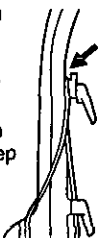

- 4 Loosely wrap the cord around both cord hooks. Secure the plug head to the cord by pushing the cord into the retainers on the plug head.

Retainer
(Plug Head)



USING THE CORD HOOK

- 1 The upper cord hook has a quick-release action. To release the cord, rotate the hook downward and the complete power cord will drop off the hook for immediate use.

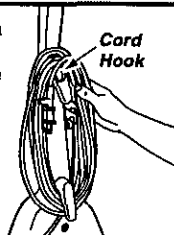

- 2 Do not unplug the power cord by pulling on the cord. Grasp the plug head and pull to unplug the vacuum cleaner.

Return the hook to the upright position before attempting to rewind the cord.



ATTACHMENT (Tools-on-Board) ASSEMBLY



CAUTION

Do not get the power cord caught under the nozzle when using the vacuum or attachments as it can be damaged by the agitator as it revolves

ATTACHMENTS

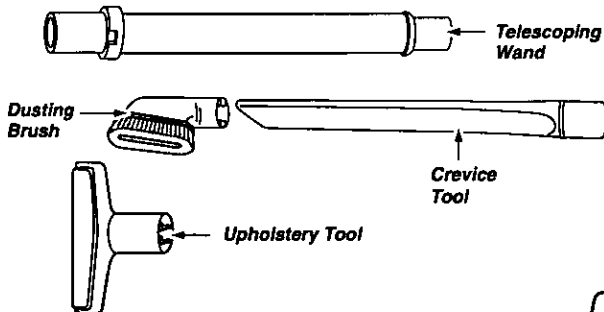

The attachments should be conveniently positioned in the back of the cleaner for easy access. Assemble the hose and attachments to the cleaner as follows:

Insert the crevice tool, cleaning end down, into the end of the telescoping wand nearest the locking ring. A slight twist of the crevice tool will lock it into place.

Place the telescoping wand in the back of the cleaner with the locking ring and crevice tool up, and the bottom resting on the ledge near the wheel.

The hose ring should be inserted into the slot to hold in place only when vacuuming areas below the upper cord hook.

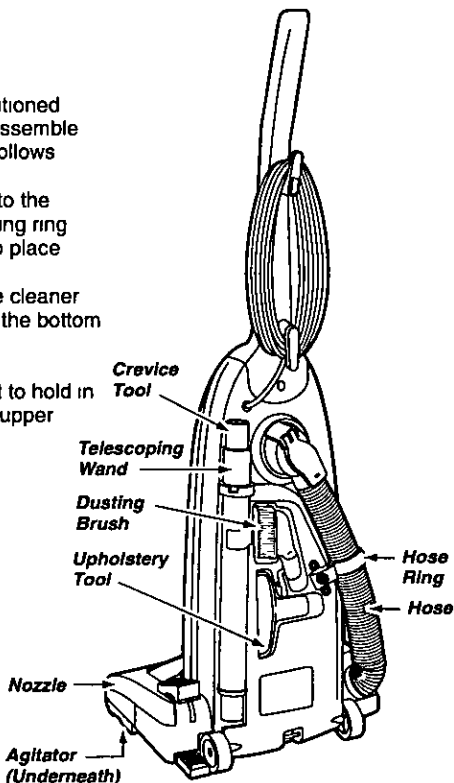

SPECIAL FEATURES OF CLEANER

AUTOMATIC SELF ADJUSTING NOZZLE

Your Panasonic upright vacuum cleaner is designed with an automatic self adjusting nozzle. No manual adjustments are required. The height of the nozzle is instantly and automatically adjusted to any carpet pile height. This self adjusting feature allows the nozzle to float evenly over all carpet pile surfaces.

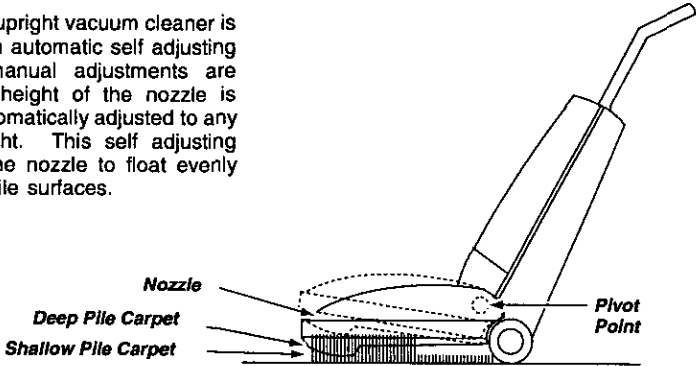

EDGE CLEANING FEATURE

The edge cleaning feature provides for improved cleaning of carpets near walls and furniture.

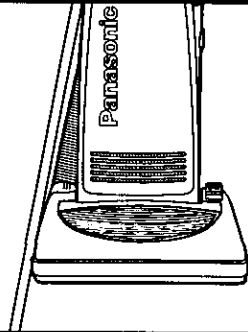

DIRT SENSOR

The electronic sensor is a feature which will detect particles as they pass through the vacuum cleaner.

Red light indicates dirt is being picked up by the cleaner. Green light indicates most of the dirt has been picked up by the cleaner.

The dirt sensor indicators and sensor sensitivity switch are located on the front top of the switch cover. See the Dirt Sensor section under To Operate Cleaner section for operation.

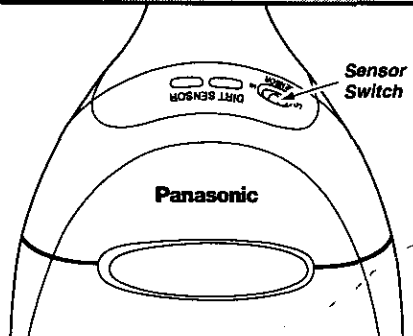

CARPET/BARE FLOOR SELECTOR

To use cleaner on bare floors, the carpet/bare floor selector on top of the nozzle should be positioned all the way back and down toward the bottom of the nozzle until it locks into place. When the selector is in this position, the agitator does not turn. This is also the correct position to place the selector in to use the attachments. When the attachments are used, the agitator should not be turning.

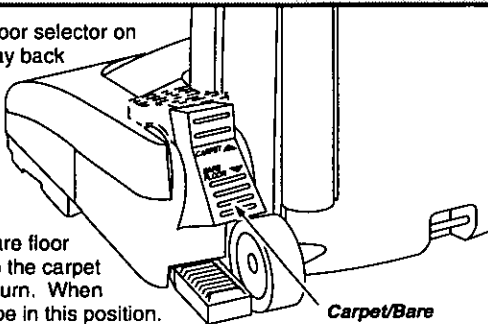

To use cleaner on carpeted areas, the carpet/bare floor selector should be all the way forward and up to the carpet position. This position will allow the agitator to turn. When carpets are being cleaned, the selector should be in this position.

Take care when selecting either position to make sure the selector is pushed fully and quickly as possible to that position. Failure to do so can cause the belt to rub on the selector shaft and may result in the belt becoming hot and creating a burning rubber smell.

To prevent injury when returning the selector to the carpet position, use caution as the selector can move quickly upward due to tension caused by the belt.

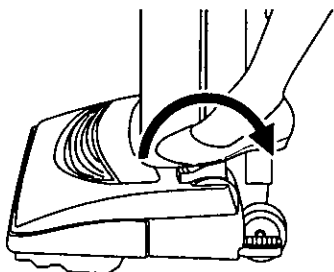

To clean bare floor or use attachments

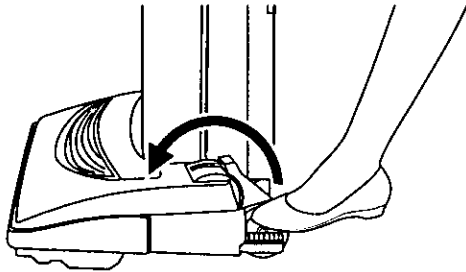

To clean carpet

HOSE RING AND HOSE RING MOUNT

The hose ring is a feature designed to prevent tipping of the vacuum while performing certain tasks that involve the use of the attachments. To use this anti-tip feature, place the hose ring in the hose ring mount as shown in the illustration. Rotate this ring on the hose so that the hose ring knob will align with the slot in the hose ring mount and slide the ring down firmly until it stops. For recommendations on when to use the hose ring and the exact location of the hose ring mount see the Use of Attachments section.

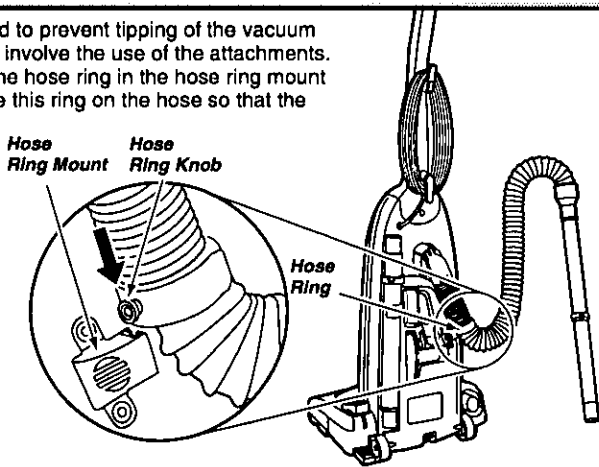

TO OPERATE CLEANER



CAUTION

Do not use outlets above counters. Damage to items in the surrounding areas could occur. Be sure the switch is in the off position while plugging the cord in.

POWER CORD

NOTE: To reduce the risk of electrical shock, this vacuum has a polarized plug, (one blade is wider than the other). This plug will fit in a polarized outlet only one way. If the plug does not fit fully in the outlet, reverse the plug. If it still does not fit, contact a qualified electrician to install the proper outlet. **DO NOT CHANGE THE PLUG IN ANY WAY.**

ON/OFF SWITCH

1. Plug the power cord into a 120V outlet.
2. To start the vacuum cleaner, push the switch to the ON position.
3. To stop the vacuum cleaner, pull the switch to the OFF position.

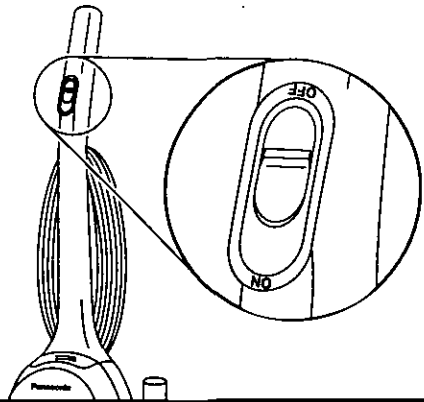

HANDLE ADJUSTMENTS

The handle may be lowered to any position required. Just step on handle release pedal as indicated by the illustration and lower the handle as desired.

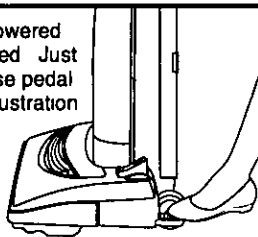

1 Upright position

The handle locks in this position for storage. The handle should always be in an upright position when the cleaning tools are used.

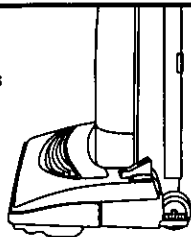

2 Middle position

This position is for normal cleaning.

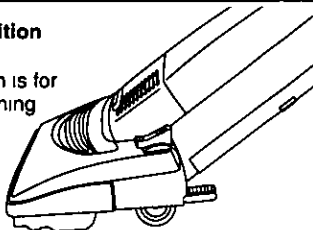

3 Low position

This position is used for cleaning under furniture.

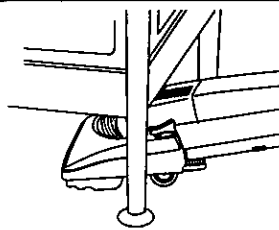

DIRT SENSOR

OPERATION - As you vacuum, the red indicator light will come on and stay on as long as the sensor detects a high concentration of particles passing through the cleaner.

The green light indicates that most of the cleaning is complete.

The sensor switch allows you to select the sensitivity of the dirt sensor. The switch can be set to Hi or Lo sensitivity.

Set the sensor switch to the Hi position when

- Cleaning bare floors
- Cleaning carpet with low pile height

Set the sensor switch to the Lo position when

- Cleaning heavily soiled areas
- Cleaning carpet with deep pile
- Cleaning new carpets

Even with the sensor switch in the Lo position, the dirt sensor will detect carpet fuzz, especially on new carpet, which may cause the red light to remain on longer than expected.

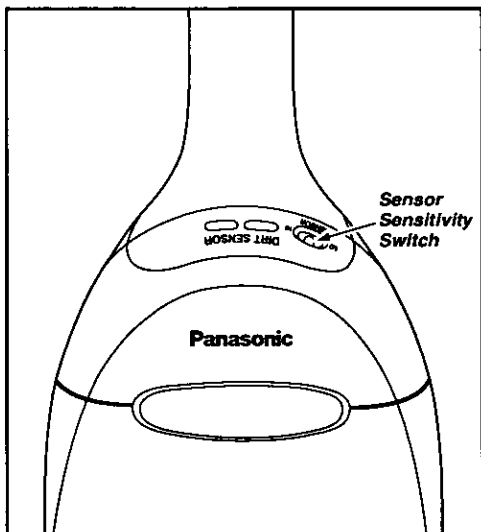



WARNING

Personal Injury Hazard when Using Attachments.

DO NOT place hands or feet underneath the unit when using the attachment tools. The agitator assembly begins to revolve rapidly when using attachments.

USE OF ATTACHMENTS



CAUTION

When using the attachments, the agitator begins rotating if the carpet/bare floor selector is not in the bare floor position. Always use the bare floor position when using attachments. Do not allow the cleaner to remain in just one place for a period of time in the carpet position as the agitator may damage the floor surface. Avoid placing the cleaner on furniture, the fringed area of rugs, deep pile carpeting, or carpeted stairs. The ideal position for the cleaner when using attachments is for the unit to be on a level area with the handle in the full upright position.



When using attachments always place the carpet/bare floor selector to the bare floor setting. To remove the hose from the nozzle, grasp the lower end of the hose at the nozzle and twist as you pull out from the nozzle. Once the hose has been removed it can be used as is, or the telescoping wand can be used for further reach. Remove the telescoping wand from the storage position on the vacuum cleaner. Remove the crevice tool from the telescoping wand by pulling out while twisting slightly. To extend the wand, turn the locking ring to the UNLOCK position as indicated on the locking ring and pull it out to full length and lock the locking ring by turning it to the LOCK position. The crevice tool, dusting brush, or upholstery tool can be attached to the hose or the end of the wand. When connecting the attachments to the hose or wand, always twist as you push down. If additional reach is required, the dusting brush or upholstery tool can be attached to the crevice tool by simply sliding them over the narrow end. The attached hose end swivels at the back of the vacuum cleaner to make cleaning easier in all directions.

When using the attachments **DO NOT** overextend your reach with the hose as it could tip the cleaner over. To help prevent tipping of the vacuum when using the attachments to clean areas below the upper cord hook the hose ring should be placed in the hose ring mount. Above this level unhook the hose ring from the mount.

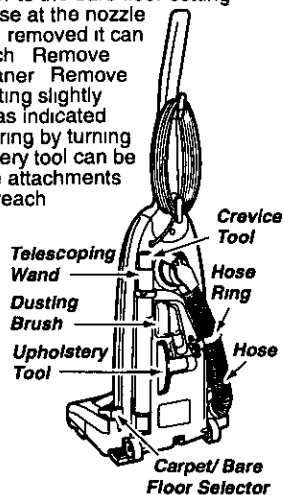
Store attachments in their proper positions as shown in the illustration and place the hose back into the nozzle.



ATTACHMENT USE

ATTACHMENT	CLEANING AREA				
	Furniture*	Between Cushions*	Drapes*	Stairs	Walls
CREVICE TOOL 	X	X	X	X	X
DUSTING BRUSH 	X		X	X	X
UPHOLSTERY TOOL 	X	X	X		

*Always clean attachments before using on fabrics. Attachments used in dirty areas (such as under a refrigerator) should not be used on other surfaces until they are washed. They could leave marks. (See the Cleaning Exterior and Attachments section.)

ROUTINE CARE OF CLEANER

Performing the following tasks will keep your new Panasonic vacuum cleaner operating at peak performance levels and will insure these high levels for years to come. Check the Before Requesting Service section in this manual for recommendations on performing some of these tasks to help solve various problems that may occur.



WARNING

Electrical Shock or Personal Injury Hazard

Always disconnect electrical supply before performing any service and/or cleaning of the vacuum cleaner. Failure to do so could result in electrical shock or personal injury from cleaner suddenly starting. Do not operate the cleaner without the secondary foam filter. Be sure the secondary foam filter is properly installed. Failure to do so could result in motor failure.

CLEANING SECONDARY FOAM FILTER

A secondary foam filter protects the motor from dirt. When installing a new dust bag, check this filter. Accumulated dirt in the dust compartment will collect on this filter and may restrict motor performance. When this filter becomes dirty, pull it from the bottom of the dust compartment and clean by rinsing it in water. When dry slide this filter back into place. Insert the secondary foam filter with a ruler or something flat. It should be fully inserted under the plastic rib projections all the way to the rear.

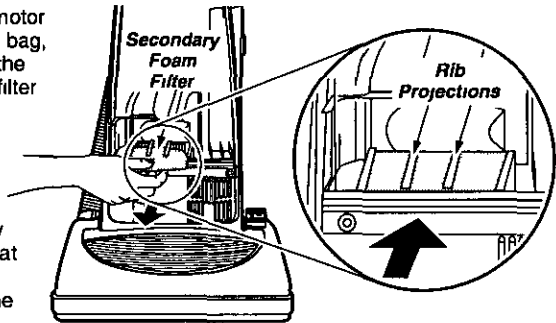

REPLACING ELECTROSTATIC EXHAUST FILTER

The electrostatic exhaust filter is located inside the dust cover. The purpose of this filter is to remove dust and dirt from the recirculated air. When installing a new dust bag, check this filter. When this filter becomes dirty, pull the filter and frame from the bottom of the dust cover by pulling straight up on the two retainers on the frame. Do one side at a time. Replace this filter. **DO NOT CLEAN WITH WATER.** Place the new filter in the frame with the four slots in the filter aligning with the four tabs on the frame. Place the frame and filter back into the dust cover making sure the rough side is facing up. Snap the frame back into place by pressing down on the retainers.

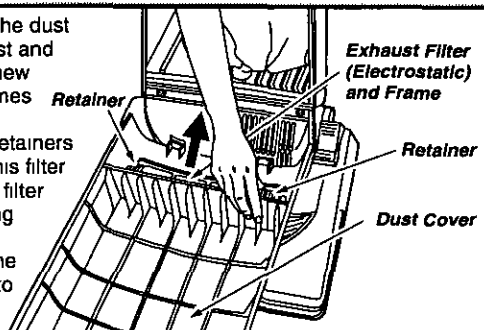

This filter cannot be cleaned and should be replaced at least once each year if the cleaner is used at least one hour each week.

CHANGING THE DUST BAG

Always operate the vacuum with a genuine Panasonic Type U3 (Standard) or U6 (Electrostatic) dust bag installed. Panasonic dust bags may be ordered through any authorized Panasonic dealer.

- 1 Pull outward on the dust cover grip, located on the top front of the dust cover and remove the cover

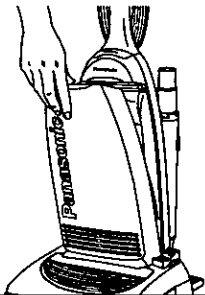

- 2 To remove the dust bag, grasp the cardboard portion of the dust bag and pull it out

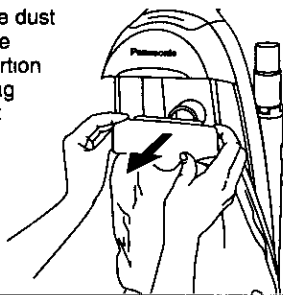

- 3 Spread out the end of the new dust bag

NOTE Pull carefully so as not to tear the bag at the folds

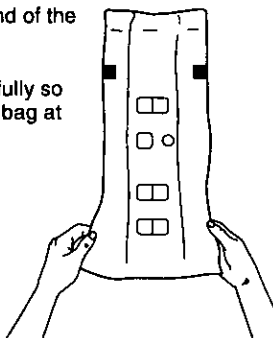

- 4 Attach the new dust bag onto the bag holder by holding the bag collar and pushing back as illustrated



- 5 Reinsert the tabs provided on the end of the dust cover into the grooves on the dust compartment to allow the cover to rotate closed

NOTE The dust cover must be completely and correctly installed for proper operation

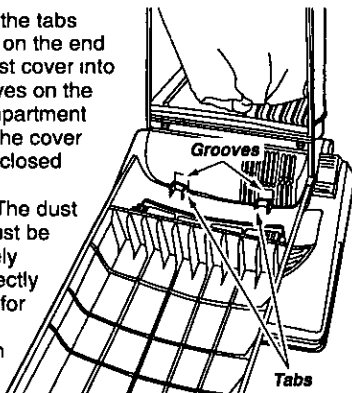

- 6 Rotate the dust cover up into the closed position and press into place

NOTE The dust bag should not be caught between the lower edge of the dust cover and the gasket as indicated by the arrow in the illustration

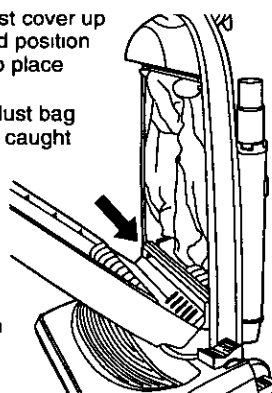



WARNING Electrical Shock or Personal Injury Hazard.

When the lower plate is removed for any reason, before reinstalling, be sure that all electrical wires are routed in a manner that prevents them from coming into contact with the lower plate, lower plate screws, or any moving parts. Be sure the wires are not pinched in any way when the lower plate is reinstalled.

REMOVING/INSTALLING THE LOWER PLATE

Before replacing any parts, disconnect the vacuum cleaner from the electrical outlet

Replacing some of the parts in this section involves the removal and installation of the lower plate. Always place paper under nozzle anytime the lower plate is removed to protect the floor surface.

To Remove Lower Plate

Start by placing the handle in the upright position (See the Handle Adjustments section). Turn the vacuum cleaner over, exposing the underside. Release the lower plate by removing the two (2) screws and pressing inward on the two (2) locking tabs that secure the lower plate. Remove the lower plate and brush or remove any residue that may exist in the belt area.

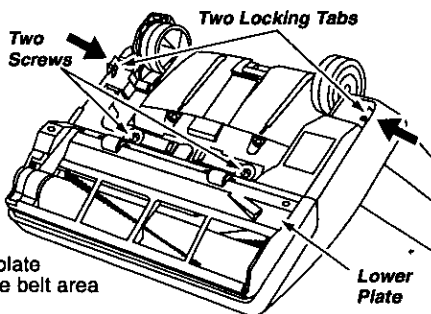

To Reinstall Lower Plate

Hook the front end of lower plate into the slots on the front of the nozzle housing. Press the lower plate into place until the locking tabs snap into place, then replace the two (2) lower plate screws.

NOTE To insure maximum cleaning efficiency, the belt should be checked regularly to make sure it is in good condition. Check to see if the belt is stretched, cracked, or if excessive slippage has occurred. Replace it if necessary.

REPLACING THE HEADLIGHT BULB

- 1 Remove the lower plate using the procedure in the Removing/Installing the Lower Plate section.
- 2 Grasp the bulb socket, wiggle the socket back and forth while pulling it up out of the nozzle housing. To remove the old bulb, push it in toward the bulb socket while turning counterclockwise, then remove.
- 3 Install the new bulb by pushing it in toward the bulb socket and turning it clockwise. Use any standard bayonet base appliance bulb rated at 15 Watts.

CAUTION Do not use a bulb rated over 15 W. During extended use, heat from the bulb could overheat surrounding plastic parts.

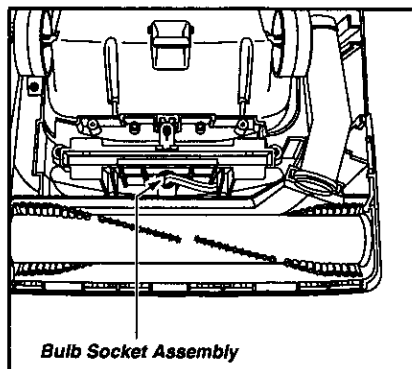

- 4 Reinsert the bulb socket into the nozzle housing by pushing it back down into the slot. Replace the lower plate as outlined in the Removing/Installing the Lower Plate section.

REPLACING THE DRIVE BELT



WARNING *Personal Injury Hazard.*

Be careful when removing agitator brush assembly. The belt tension is high. Failure to do so could result in personal injury from agitator brush assembly releasing quickly and snapping away.

Place the carpet/bare floor selector in the carpet position. Remove the lower plate as described in the Removing/Installing the Lower Plate section.

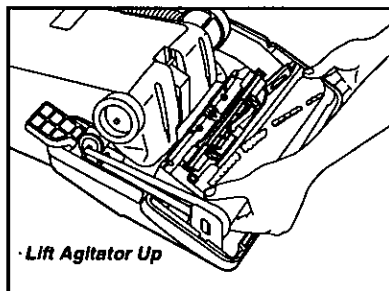

Remove the agitator brush assembly, (carefully lift it out), and remove the worn or broken belt from the agitator pulley and motor shaft.

CAUTION: The two end caps may come off along with the two washers as you lift the agitator assembly out. **Do not** lose the two small washers.

Loop the new belt around the motor shaft and loop it around the agitator pulley. See illustration for correct belt routing. Use only a **Panasonic Type UB8 drive belt**.

Before inserting the agitator brush assembly make sure the end caps/washers are on correctly. (See illustration in the Replacing the Agitator Assembly section.)

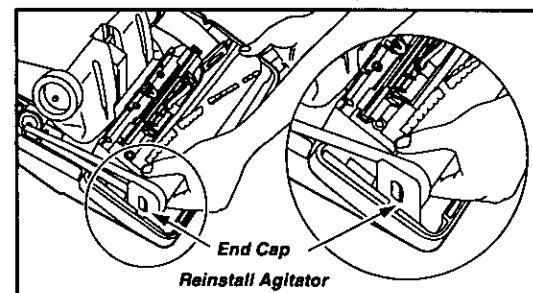
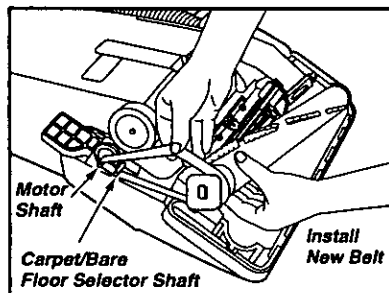

After checking the end caps, reinstall the agitator brush assembly back into the housing grooves. After installing the agitator brush assembly, turn it by hand making sure that the belt is not twisted or pinched and all rotating parts turn freely. Replace the lower plate as described in the Removing/Installing the Lower Plate section.

CLEANING THE AGITATOR ASSEMBLY

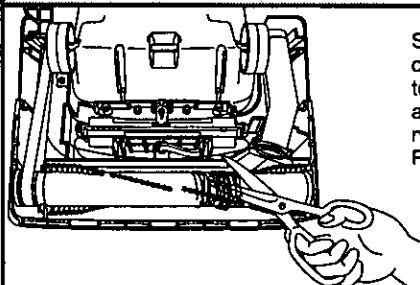

Switch off the vacuum cleaner and unplug the power cord before cleaning the agitator assembly. In order to keep the cleaning efficiency high, clean the agitator assembly regularly. Remove the lower plate if necessary. See the Removing/Installing the Lower Plate section for the proper procedure.

Agitator assembly - Cut off any carpet pile and lint entangled around the agitator assembly with a pair of scissors as illustrated.

REPLACING THE AGITATOR ASSEMBLY

1 When to replace the agitator assembly

The agitator assembly should be replaced when the brushes are worn. Brushes should be checked by holding a card across the lower plate (see illustration). If the bristles on the agitator assembly **do not** touch the card, you **should** replace the agitator assembly for best cleaning results.

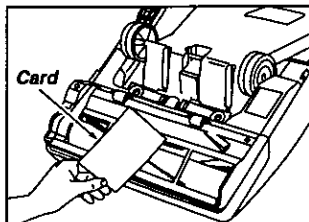

2 How to replace the agitator assembly

Place the vacuum cleaner handle in the upright position (See the Handle Adjustments section.) Remove the lower plate as outlined in the Removing/Installing the Lower Plate section. After the lower plate is removed, carefully lift up the agitator assembly until it clears both sides of the nozzle housing. While holding the agitator assembly up, remove the belt.

CAUTION The two end caps may come off along with the two washers as you lift the agitator assembly out. **Do not** lose the two small washers. Look at the exploded view of the agitator assembly below for correct assembly of the parts.

3 To replace the agitator assembly

Place the belt over the belt pulley on the agitator unit. (NOTE: There is a place for the belt to fit on one end of the agitator assembly only.) Replace both washers and end caps (see illustration below for correct assembly). After assembling the belt, washers and end caps, place the agitator assembly back into the nozzle housing by aligning each end cap.

After completing the assembly, rotate the brush, turning it by hand to assure that it rotates smoothly and the part is assembled correctly.

Replace the lower plate as outlined in the Removing/Installing the Lower Plate section.

AGITATOR ASSEMBLY

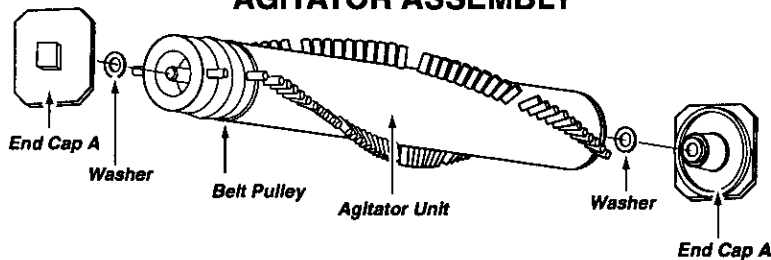

CLEANING DIRT SENSOR OPTICS

The dirt sensor optics consists of two optic cells located inside the bag holder. Occasionally, it may become necessary to clean the two optic cells to assure maximum performance. It is recommended the optic cells be cleaned:

- When the red light does not light.
- When dirt or dust adheres to the optic cells.
- Whenever the dust bag is changed.

To clean the sensor, wipe the optic cells with a soft, dry cloth. Never use cleaners or liquids as they can help speed the recoating of the optic cells and make it necessary to clean them much sooner than normal. The dirt sensor area can be reached by removing the dust cover and the dust bag.

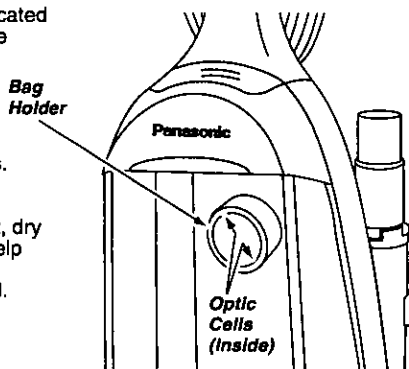

CLEANING EXTERIOR AND ATTACHMENTS

1. Unplug cord from wall outlet. **DO NOT drip water on cleaner.**
2. Clean exterior using a clean, soft cloth that has been dipped in a solution of mild liquid detergent and water, then wrung dry. Wipe dry after cleaning.
3. To reduce static electricity and dust build-up, wipe outer surface of cleaner and attachments.
4. Wash attachments in warm soapy water, rinse and air dry. **Do not clean in dishwasher or clothes washer.**

DO NOT USE ATTACHMENTS IF THEY ARE WET.



CAUTION

Attachments used in dirty areas (such as under a refrigerator) should not be used on other surfaces until they are washed. They could leave marks.

REMOVING CLOGS

The hose located on the back of the vacuum cleaner carries the dirt from the nozzle up to the dust bag. If the hose should become clogged:

1. Pull down on the suction inlet cover and check for clogging in this area.
2. Disconnect the hose from the nozzle and check the hose for clogging. Plug in the vacuum cleaner and turn it on. While running the vacuum cleaner with the hose disconnected, stretch the hose in and out to remove the clog.
3. If the clog still exists, turn the vacuum cleaner "OFF" and unplug the power cord. Turn the vacuum cleaner over, exposing the underside. Remove the lower plate. Remove the short nozzle pipe from the nozzle by lifting it straight up. Inspect the hose end and nozzle pipe and clear them of any obstructions. Reinstall the nozzle pipe, lower plate and nozzle hose. See the Removing/Installing the Lower Plate section for detailed instructions.

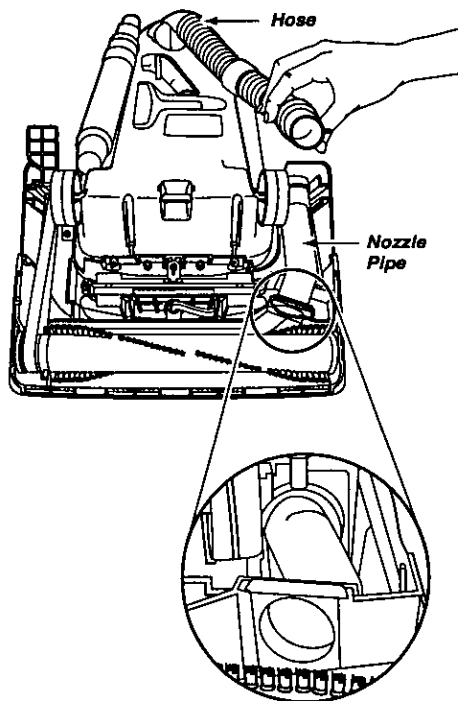
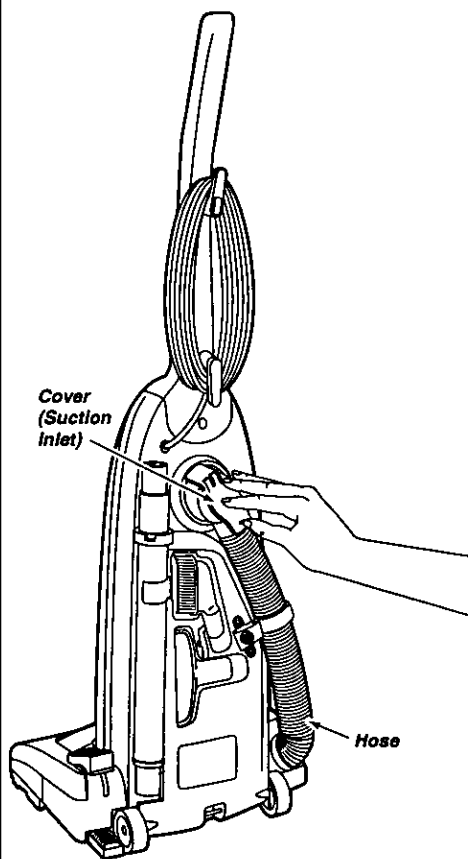

BEFORE REQUESTING SERVICE



WARNING *Electrical Shock or Personal Injury Hazard.*

Disconnect the electrical supply before servicing or cleaning the unit. Failure to do so could result in electrical shock or personal injury from cleaner suddenly starting.

Review this chart to find do-it-yourself solutions for minor performance problems. Any service needed, other than those described in these Operating Instructions, should be performed by an authorized service representative.

PROBLEM	POSSIBLE CAUSE	POSSIBLE SOLUTION
Cleaner will not run.	<ol style="list-style-type: none"> 1. Unplugged at wall outlet. 2. On/Off switch not turned on. 3. Tripped circuit breaker/blown fuse at household service panel. 	<ol style="list-style-type: none"> 1. Plug in firmly. Push On/Off switch to On. 2. Push On/Off switch to On. 3. Reset circuit breaker or replace fuse.
Poor job of dirt pickup.	<ol style="list-style-type: none"> 1. Full or clogged dust bag. 2. Carpet/bare floor setting incorrect. 3. Broken belt. 4. Clogged hose or nozzle. 5. Hose not inserted fully. 6. Worn agitator assembly. 7. Hole in hose. 8. Dust cover improperly installed. 9. Belt not installed on motor shaft. 	<ol style="list-style-type: none"> 1. Change bag. 2. Set in the correct position. 3. Replace belt. 4. Clean hose or nozzle area. 5. Insert hose. 6. Replace agitator assembly. 7. Replace hose. 8. Properly install dust cover. 9. Install belt on motor shaft.
Bare floor option will not work.	<ol style="list-style-type: none"> 1. Belt improperly installed with bare floor selector in wrong position. 	<ol style="list-style-type: none"> 1. Properly install belt.
Light will not work.	<ol style="list-style-type: none"> 1. Burned out light bulb. 	<ol style="list-style-type: none"> 1. Replace light bulb.
Dust escapes the paper bag.	<ol style="list-style-type: none"> 1. Bag improperly installed. 2. Bag torn. 	<ol style="list-style-type: none"> 1. Properly install bag. 2. Replace bag.
Dirt Sensor will not work.	<ol style="list-style-type: none"> 1. Dirty optic cells. 	<ol style="list-style-type: none"> 1. Clean optic cells.

NOTES

NOTES

WARRANTY

Panasonic Vacuum Cleaner Limited Warranty

MATSUSHITA CONSUMER ELECTRONICS COMPANY OR PANASONIC SALES COMPANY (collectively referred to as the warrantor) will repair this product with new or refurbished parts free of charge, in the U.S.A. or Puerto Rico one (1) year from the date of original purchase in the event of a defect in materials or workmanship. Excluded are the following items which require normal replacement: Disposable Dust Bag, Filters, Belts, Light Bulb, Agitator Brushes and Battery (if supplied).

Carry-in service in the continental U.S.A. can be obtained during the warranty period from a Matsushita Services Company (MSC) Factory Servicenter. To locate an authorized MSC Servicenter call 1-800-545-2672 toll free. Service in Puerto Rico can be obtained during the warranty period by calling the telephone numbers listed in the Servicenter Directory. This warranty is extended only to the original purchaser. A purchase receipt or other proof of date of original purchase will be required before warranty performance is rendered.

This warranty only covers failures due to defects in materials or workmanship which occur during normal use and does not cover damage which occurs in shipment or failures which are caused by products not supplied by the warrantor, or failures which result from accident, misuse, abuse, neglect, mishandling, misapplication, alteration modification of the product, or commercial use such as hotel, office, restaurant or rent use of the product, or service by anyone other than an authorized Servicenter, or damage that is attributable to acts of God.

LIMITS AND EXCLUSIONS: There are no express warranties except as listed above.

The warrantor SHALL NOT BE LIABLE FOR INCIDENTAL OR CONSEQUENTIAL DAMAGES RESULTING FROM THE USE OF THIS PRODUCT, OR ARISING OUT OF ANY BREACH OF THIS WARRANTY. ALL EXPRESS AND IMPLIED WARRANTIES, INCLUDING THE WARRANTIES OF MERCHANTABILITY AND FITNESS FOR A PARTICULAR PURPOSE, ARE LIMITED TO THE APPLICABLE WARRANTY PERIOD SET FORTH ABOVE. Some states do not allow the exclusion or limitation of incidental or consequential damages or limitations on how long an implied warranty lasts, so the above exclusions or limitations may not apply to you.

This warranty gives you specific legal rights and you may also have other rights which vary from state to state.

If a problem with this product develops during or after the warranty period, you may contact your dealer or Servicenter. If the problem is not handled to your satisfaction, then write to the Customer Satisfaction Center at the listed address on the back cover.

WHAT TO DO WHEN SERVICE IS NEEDED

If your Panasonic Vacuum Cleaner needs service, look in the yellow pages of the telephone book under "Home Appliance Service" for your nearest Matsushita Service Company ("MSC") Factory Servicenter, or MSC authorized Servicenter, or call 1-800-545-2672, toll free to find a convenient servicenter. Do NOT send the product to the Executive or Regional Sales offices. They are NOT equipped to make repairs.

If you ship the product

Carefully pack and send it prepaid, adequately insured and preferably in the original carton. Attach a postage-paid letter to the outside of the carton, which contains a description of your complaint. **DO NOT send the product to the Executive or Regional Sales Offices. They are NOT equipped to make repairs.**

Customer's Record

Model No _____ Dealer's Name _____

Serial No _____

Dealer's Address _____

Date of Purchase _____

Consumers requiring product information or operating assistance with a consumer product should contact

CUSTOMER SATISFACTION CENTER DEPARTMENT 2F-3

50 Meadowlands Parkway
Secaucus, N J 07094
(201) 348-9090

**DIAL TOLL FREE
1-800-545-2672**

Matsushita Services Co.

**24 hours a day,
7 days a week**

MATSUSHITA CONSUMER ELECTRONICS
COMPANY, DIVISION OF MATSUSHITA ELECTRIC
CORPORATION OF AMERICA

One Panasonic Way
Secaucus, New Jersey 07094

PANASONIC SALES COMPANY, DIVISION OF
MATSUSHITA ELECTRIC OF PUERTO RICO INC
("PSC")

AVE 65 de Infanteria, Km 9.5
San Gabriel Industrial Park
Carolina, Puerto Rico 00985
Tel (809) 750-4300 Fax (809) 768-2910